



# **COLORLITE<sub>Q120</sub>**



## **USER MANUAL**

### **Table of Contents**

Safety Information	3
Specifications	4
Photometrics	5
Main Power Connection	6
DMX-512 Connection	6
DMX Profile	7
Main Control Menu	9
Size and Weight	11
Rigging the Fixture	12
Cleaning & Maintenance	13



Check that the unit has not been damaged during transport



Read all cautions and warnings  
prior to operation of this  
equipment

#### Protection Against Fire



1. Maintain a minimum of 1 foot distance from any type of flame.
3. Replace fuse only with the specified type and rating.
4. Do Not install the unit too close to a heat source.
5. Make sure cables are properly secured
6. Maximum surface operating temperature 140°.

#### Protection Against Electrical Fire

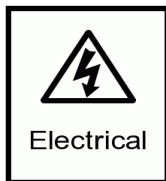

1. Disconnect power before servicing.
2. For connection to main power supply proceed to page 6.
3. This unit must be earthed. (electronically grounded)
4. This fixture must not be left on for long periods of time.

#### Protection Against Mechanical Hazards



1. Use safety chain when hanging unit.
2. Use quality clamps or bolts when positioning unit
3. Do not open unit while it is on, risk of electrical shock.

#### Ingress Protection



The IP rating is commonly expressed as **IP (Ingress Protection)** is followed by 2 numbers (i.e. 65) where the numbers define the fixture rating. The first number indicates the size of a particle that can enter the fixture.. The second number indicates the extent of protection against water entering the fixture. An IP65 rating in this fixture indicates that dust particles can not enter the fixture. And there is protection against powerful water spray from entering the fixture from any direction.

# Technical Information

## Part Numbers

---

### Fixture

**4300-ColorLite Q120**

## Mechanical Specifications

---

**DMX Connectors:** Cable Mounted IP67 5-pin XLR connectors in/out

**Power Connections:** Panel mount Neutrik True Power in/out connection (Nema 5-15 to Neutrik True power male cable included)

**Thermal:** Maximum ambient temperature 40° C  
Maximum surface temperature 60° C

**Display:** Digital

**Fastening System:** Dual Mounting Yoke

**Lens Angle:** 40°

**Ip Rating:** IP65

**Pendant Mount:** Treaded 1/2 inch female, Eye Hook

## Electrical Specifications

---

**LED Type:** 1 COB LED

**Color Type:** Red, Green, Blue, Warm White

**CRI:** 90 on Warm White

**CCT:** 2831K on Warm White

**LED Watts:** 120

**LED Lifetime:** 60,000 to 100,000 hours

**Power Consumption:** Universal 100 - 240V 50/60 Hz

**Ballast:** Electronic

**Watts:** 122W

**Amps:** 1.69A

**PF:** .58

## Control & Programming

---

**Protocol:** DMX 512

**DMX Channels:** 5 Mode of Operation

Mode 3 Channel Red, Green, Blue

Mode 4 Channel Red, Green, Blue, Warm White

Mode 5 Channel Dimmer, Red, Green, Blue, Warm White

Mode 7 Channel Dimmer, Red, Green, Blue, Warm White, Strobe, Macro

Mode 8 Channel Dimmer, Red, Green, Blue, Warm White, Strobe, Macro, Dim Curve

**Operating Mode:** Stand alone 255 step dimmer setting via display  
Auto preprogram via display

# Photometrics

Output @ Full

Lens	Lumens at Full Output	Efficiency
40°	2587	21lm/W

Foot Candle and Lux with 40° Lens

Distance	Foot Candle / Lux	Beam Diameter
5'	185fc / 1156lux	3.7'
10'	46fc / 289lux	7.3'
15'	21fc / 128lux	11.0'
20'	12fc / 72lux	14.7'

## CRI 90

on Warm White Emitter only

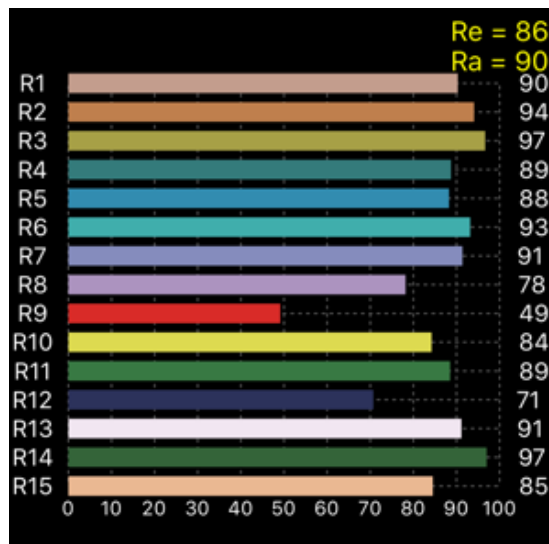



# Main Power Connection

## Caution!

1. Do not connect fixture to a dimmer system.
2. This unit has Auto switching power supply. It will respond to 110V or 220V automatically
3. This unit must be earthed. (electronically grounded)
4. Replace fuse only with the specified type and rating.

The occupation of the connection-cable is as follows:

This fixture is equipped with an electronic power supply that will let the unit operate from 100V to 240V from 50Hz to 60Hz

Cable (USA)	Cable (EU)	Pin	110V	220V
Black	Brown	Live	L	L
White	Light Blue	Neutral	N	L
Green	Yellow/Green	Ground		

### 110V—Connection

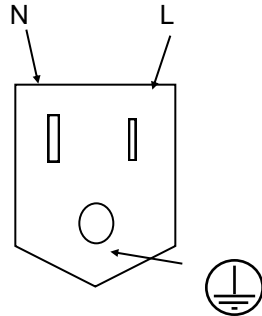

### 220V—Connection

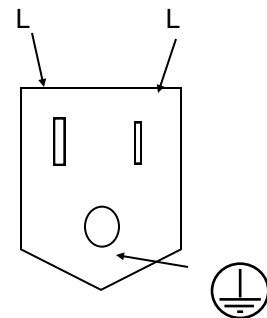

## DMX-512 Connection

The fixture is equipped with 5 pin XLR cable mounted sockets for DMX input and output. The sockets are wired in parallel. Only use a shielded twisted pair cable designed for RS-485 and 5 pin XLR plugs and connectors in order to connect the controller with the fixture or the fixture with another.

### DMX—input

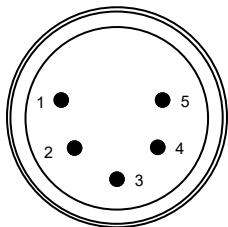

1. Shield
2. Signal (-)
3. Signal (+)
4. N/A
5. N/A

### DMX—output

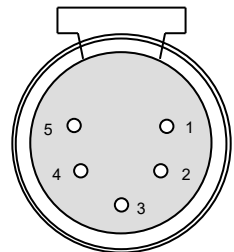

## Caution!

At the last fixture the DMX signal needs to be terminated with a terminator. Solder a 120 Ohm resistor between the (-) and the (+) signal into a 3 or 5 pin XLR plug and plug it in to the last fixture on the signal run. Pre-manufactured terminator plugs are available for purchase from your Mega-Lite dealer (P-DMXT).

## DMX Profile

### Colorlite Q120 3CH Mode

DMX Channel	Function	Description	Value
1	LED Color	Red LED intensity	0-255
2	LED Color	Green LED Intensity	0-255
3	LED Color	Blue LED Intensity	0-255

### Colorlite Q120 4CH Mode

DMX Channel	Function	Description	Value
1	LED Color	Red LED intensity	0-255
2	LED Color	Green LED Intensity	0-255
3	LED Color	Blue LED Intensity	0-255
4	LED Color	Warm White LED Intensity	0-255

### Colorlite Q120 5CH Mode

DMX Channel	Function	Description	Value
1	Dimmer	Dimmer	0-255
1	LED Color	Red LED intensity	0-255
2	LED Color	Green LED Intensity	0-255
3	LED Color	Blue LED Intensity	0-255
4	LED Color	Warm White LED Intensity	0-255

### Colorlite Q120 7CH Mode

DMX Channel	Function	Description	Value
1	Dimmer	Dimmer Off to Full	0-255
2	LED Color	Red LED intensity	0-255
3	LED Color	Green LED Intensity	0-255
4	LED Color	Blue LED Intensity	0-255
5	LED Color	Warm White LED Intensity	0-255
6	Strobe	No Function	0-1
		Strobe (slow to fast)	2-196
		Random Strobe (slow to fast)	197-255
7	Macro	No Function	0-1
		Color fade All (slow to fast)	2-19
		Color Snap All (slow to fast)	20-39
		Random Color Snap (slow to fast)	40-59
		Red fade (slow to fast)	60-79
		Green fade (slow to fast)	80-99
		Blue fade (slow to fast)	100-119
		Warm White fade (slow to fast)	120-139
		Macro Effect 1	140-159
		Macro Effect 2	160-179
		Macro Effect 3	180-199
		Macro Effect 4	200-219
		Macro Effect 5	220-229
Macro Effect 6	230-249		
Macro Effect 7	250-255		

# Colorlite Q120 8CH Mode

DMX Channel	Function	Description	Value
1	Dimmer	Dimmer Off to Full	0-255
2	LED Color	Red LED intensity	0-255
3	LED Color	Green LED Intensity	0-255
4	LED Color	Blue LED Intensity	0-255
5	LED Color	Warm White LED Intensity	0-255
6	Strobe	No Function	0-1
		Strobe (slow to fast)	2-196
		Random Strobe (slow to fast)	197-255
7	Macro	No Function	0-1
		Color fade All (slow to fast)	2-19
		Color Snap All (slow to fast)	20-39
		Random Color Snap (slow to fast)	40-59
		Red fade (slow to fast)	60-79
		Green fade (slow to fast)	80-99
		Blue fade (slow to fast)	100-119
		White fade (slow to fast)	120-139
		Macro Effect 1	140-159
		Macro Effect 2	160-179
		Macro Effect 3	180-199
		Macro Effect 4	200-219
		Macro Effect 5	220-229
		Macro Effect 6	230-249
Macro Effect 7	250-255		
8	Dimming Curve	No Function	0-15
		Curve 1 Linear Smooth	16-45
		Curve 2 Square Law Smooth	46-75
		Curve 3 Inv Square Law Smooth	76-105
		Curve 4 S-Type Smooth	106-135
		Curve 1 Linear Fast	136-165
		Curve 2 Square Law Fast	166-195
		Curve 3 Inv Square Law Fast	196-225
		Curve 4 S-Type Fast	226-255



# Main Control Menu

The control board on the fixture is your interface to access and control all the functions on the unit. Its digital display gives you a code view of the options and functions. The following will explain each function and its options.

## CONTROL BOARD

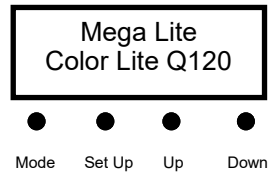

DMX

### DMX Address

Press **Set Up** to select the DMX start channel use the **up/down** keys, Press **Set Up** to confirm the setting

Channel Mode

### DMX Mode

This function allows you to select the mode in which you want to control the fixture. Press **Set Up** use the **up/down** keys to select desired DMX mode settings. Press **Set Up** to confirm the settings.

3 CH	Red, Green, Blue
4 CH	Red, Green, Blue, Warm White
5 CH	Dimmer, Red, Green, Blue, Warm White, Strobe
7 CH	Dimmer, Red, Green, Blue, Warm White, Strobe, Macro
8 CH	Dimmer, Red, Green, Blue, Warm White, Strobe, Macro, Dim Speed

Dimmer

### Color Dimmer

This function allows you to dim up or down the LED's . Press **Set Up** use the **up/down** keys to select desired color to adjust settings.

Red  
Val:000

Green  
Val:000

Blue  
Val:000

WW  
Val:000

Use the **up/down** keys to select desired color to adjust. Press **Set Up** to confirm.  
(note; Last set color will return when in Color Dimmer mode.)

Auto

## Auto Pre Programs

Press **Set Up** to select yes or no use the **up/down** keys, Press **Set Up** to confirm the setting.

(note for DMX Mode operation auto must be on the off position)

Program

## Programs

Press **Set Up** to select the program that will be used in Auto program use the **up/down** keys to select from 1-14, Press **Set Up** to confirm the setting.

Info

## Info

Tempera-  
ture

Fixture Temperature reading

Software  
Version

Fixture operating software version

RDM  
UID

RDM ID number

# Size and Weight

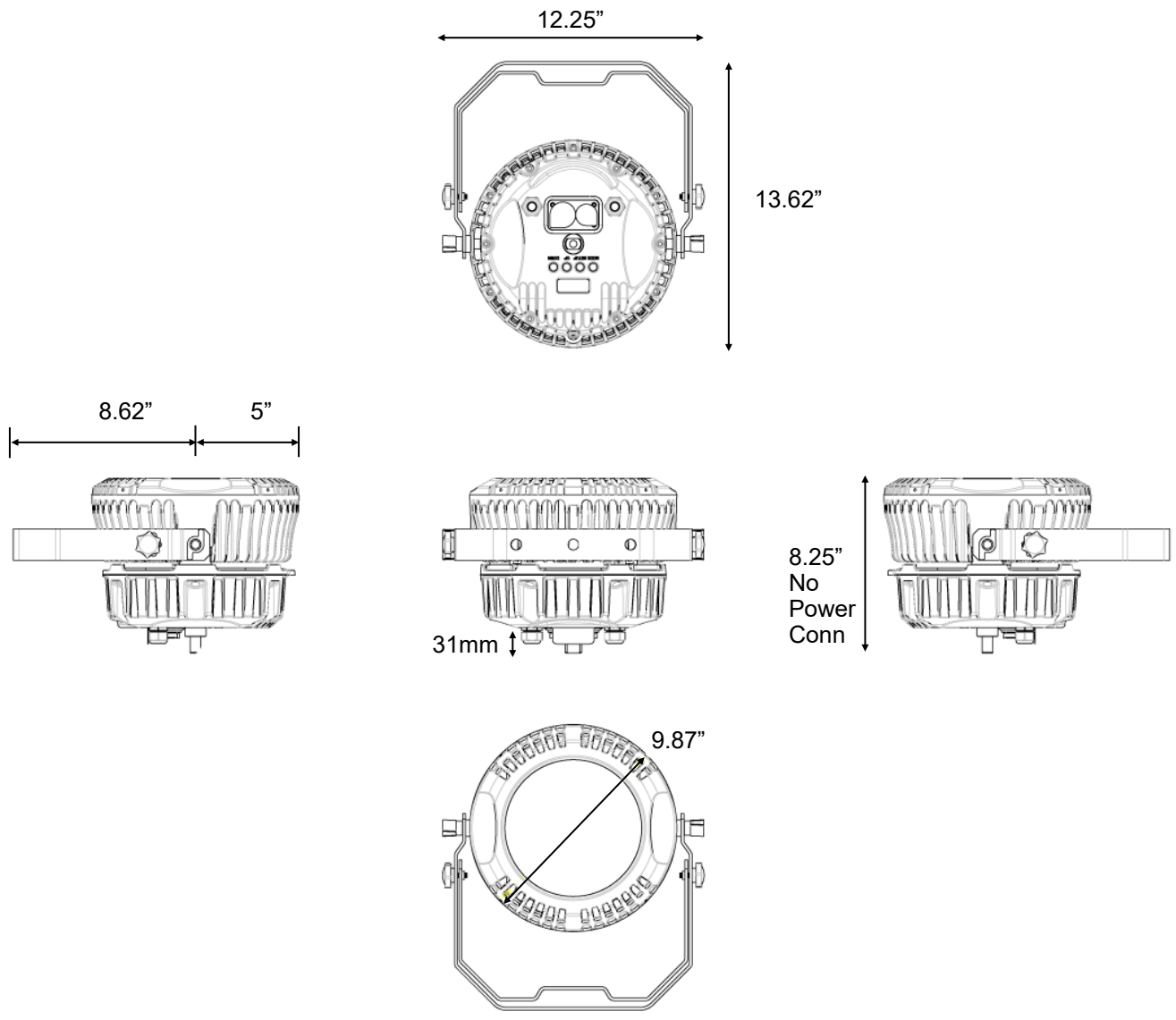

## Size

12.25" x 8.25" x 13.62"

## Packaged Size

13.5" x 10.75" x 17"

## Weight

Net 14lb

Gross 17lb

## Rigging the fixture

### Caution!

1. The installations must be carried out by an authorized dealer or trained professional.
2. Unit may cause severe injures if you have doubts concerning the safety do not install.
3. Unit is to be 24inches away from flammable materials (decoration material)
4. Use high quality installation equipment to hang unit.

When rigging a unit it is very important that you follow common safety procedures. Rigging requires extensive experience including but not limited to calculating working loads, material being used and periodic safety inspections. If you lack these qualifications, do not attempt the installation yourself, instead use a professional structural rigger.

When rigging the unit always be secured with a secondary safety attachment. The installation location of the projector has got to be built in the way that it can hold 10 times the weight for 1 hour with out any harming. Installation should be checked at least one time a year by a skilled person.

## Cleaning and maintenance

**Installation Maintenance:** The operator has to make sure that the unit is operating safely and has the installations and electronics checked by an expert every 2 years.

The following points have to be considered during the inspection:

- 1) All screws used for installing the device or part of the device have to be tightly connected and must not be corroded.
- 2) There must not be any deformations on the housing, fixation and installation spots (ceiling, suspension, trussing).
- 3) The electronic power supply cables must not show any damages, material fatigue (e.g. porous cables) or sediments.  
Further instructions depending on the installation spot and usage have to be adhered by a skilled installer and any safety problems have to be removed.

**Note:** There is no serviceable parts inside the device except for the LED's. Maintenance and service operations are to be carried out by authorized dealers.

**Replacing the fuse:** When possible only replace the fuse with the same type and rating.

**Replacing the power cable:** If the power cable of this device becomes damaged, it has to be replaced by authorized dealers or trained professional only.

**Should you have further questions , please contact your dealer.**

## Parts List

4300-LED	LED
4300-PCB-MAI	Main PCB card
4300-POW	Power Supply
4300-CON-POW	Male & Female Power Connection
4300-KNO-SMA	Small Knob Set
4300-HOU-PEN	Pendant Mount
4300-PCB-DRI	LED Driver
4300-PCB-DIS	Display
4300-GLA	Front Glass

## Accessories

4300-ACC-BAR	Barn Door
4300-ACC-TOP	Top Hat



# Warranty Information

## Warranty Conditions

-Unless otherwise stated in writing, your product is covered by a one year parts and labor limited warranty.

-LED's and LAMPS are not guaranteed to match in color temperature or output.

-It is the owner's responsibility to furnish receipts or invoices for verification of purchase, date, and reseller or distributor. If purchase date cannot be provided, date of manufacture will be used to determine warranty period.

-Goods returned under warranty must follow the proper authorization procedure and must be accompanied by a copy of the original invoice.

-Goods repaired under warranty will be returned to the owner with the freight prepaid by MSI via the most economical means of shipment.

-Repair or replacement as provided for under this warranty is the exclusive remedy of the consumer. MEGA SYSTEMS INC. makes no warranties, express or implied, with respect to any product, and Mega Systems specifically disclaims any warranty of merchantability or fitness for a particular purpose. Mega Systems shall not be liable for any indirect, incidental or consequential damage, including lost profit, sustained or incurred in connection with any product or caused by product defect or the partial or total failure of any product regardless of the form of action, weather in contract, tort (including negligence), strict liability or otherwise, and weather or not such damage was foreseen or unforeseen.

- Warranty is void if the product is misused, damaged, modified in any way, or for unauthorized repairs or parts. This warranty gives you specific legal rights, and you may also have other rights which vary from state to state.

# Customer Support

Mega Lite has a customer support line to provide set up help and to answer any question should you encounter a problem. Please visit our website for any other related technical documents. For service related issue please contact our service dept.

Monday—Friday 9am to 6pm CST  
Voice: 210-684-2600  
E-mail: [service@megasystemsinc.com](mailto:service@megasystemsinc.com)

# Manual Version

Please Visit [www.mega.lighting](http://www.mega.lighting) for the most up to date manual version

Document Version	Date	Fixture Software	Notes
1.1	12/15/2018	V1.1	



Mega-Lite  
18668 Highway 16N  
Helotes, Texas 78023  
Ph 210-684-2600 Fax 210-855-6279  
[www.mega.lighting](http://www.mega.lighting) / [info@mega.lighting](mailto:info@mega.lighting)